

4 Basics of CIUMon

4.1 Overview

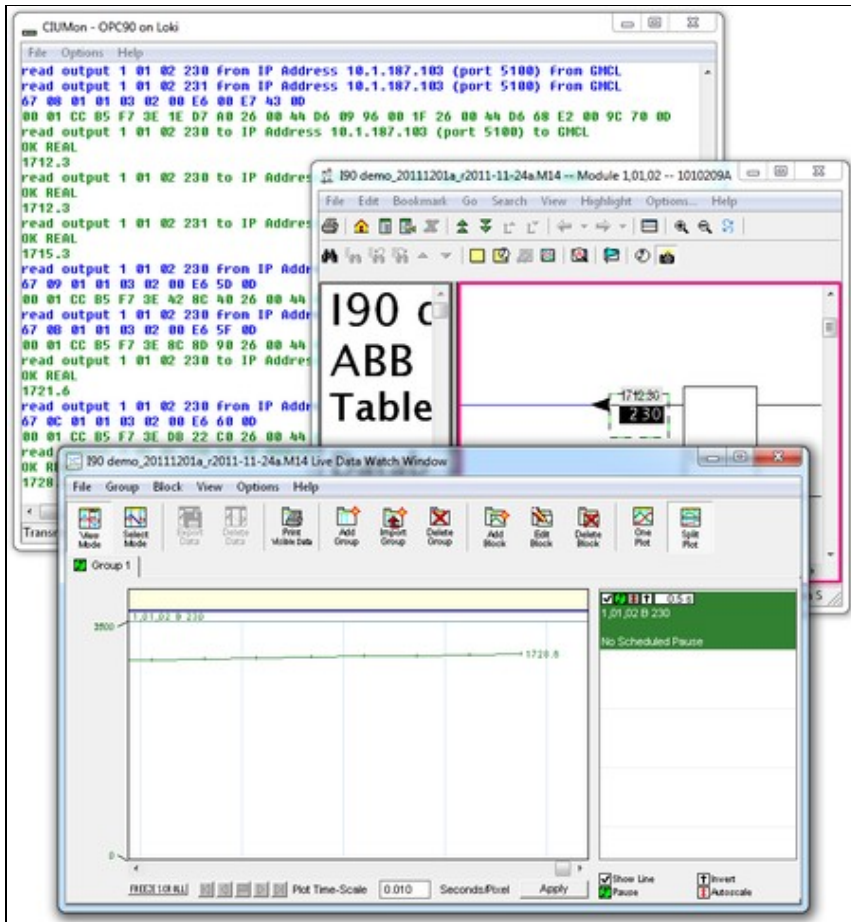

With a connection to your CIU, Hyperview can:

- display current values on CAD sheets and graphics
- display selected block values in annotations on any document
- track selected block values and graph them
- display the status of selected modules
- display values from any part of your system with a connection to a CIU on any loop

Hyperview gets live data through CIUMon. CIUMon handles all communication with the CIU. It provides live data over your network, and can provide live data to multiple users at the same time.

CIUMon cannot provide live data from a PI system, although information about your PI system can be included in your project.

4.1.1 Technical requirements

CIUMon is an interface program that provides read-only access to a CIU interface, via TCP/IP. This program conforms to the specification provided by the *Enhanced Computer Interface Unit Programmer's Reference Manual*, INFI 90 E93-905-9, with extensions that we have discovered. CIUMon can run on Windows 7, Windows 2008 R2, as well as all later versions of Windows. (For older versions of Windows such as Windows XP, Windows NT4, or Windows 2000, we can provide archived versions of CIUMon that will work but do not have the latest features.) The requirements to run CIUMon are as follows:

- The host and client computers must be running a TCP/IP stack.
- For Windows PCs, the preferred operating system and stack is the native Microsoft Network that is provided with Microsoft Windows operating systems.

CIUMon allows you to collect live data from your plant loop:

- CIUMon uses the maintenance interface available to your EWS, which is polled. It can fetch 10-20 values per second.
- CIUMon cannot replace a console, as it has no access to exception reports, alarms or history.
- You can increase throughput with multiple SPMs, or by using RoviSys Turbo.
- CIUMon keeps track of the incoming requests from all clients. If a data request comes in while there is still an outstanding one on the CIU for the same block, CIUMon will not send the request again. Instead, when CIUMon receives an answer to its original request, it will then send that value back to all clients that requested that particular piece of information.

CIUMon communicates via UDP (User Datagram Protocol)

- UDP is a data unreliable connectionless protocol
- Its robustness and tolerance of network connection problems that may be encountered make it ideal for use in CIUMon
- It reduces the likelihood of errors that may come with more complicated communication protocols

4.2 Methods of connecting CIUMon to a CIU

Once CIUMon is installed, decide which method of connecting to a CIU is appropriate for your setup. Then, connect to your CIU either directly, through RoviSys Turbo, or through Harmony OPC Server. Finally, set up CIUMon to run automatically.

CIUMon can be connected directly to some types of CIU.

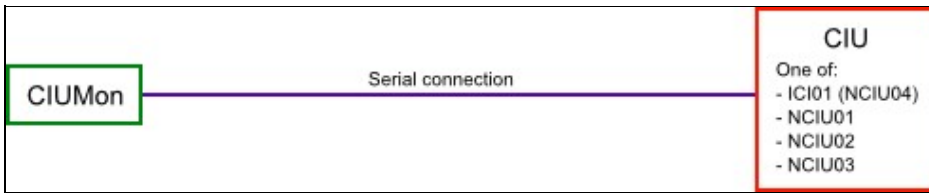

For other types of CIU, CIUMon must be connected through RoviSys Turbo.

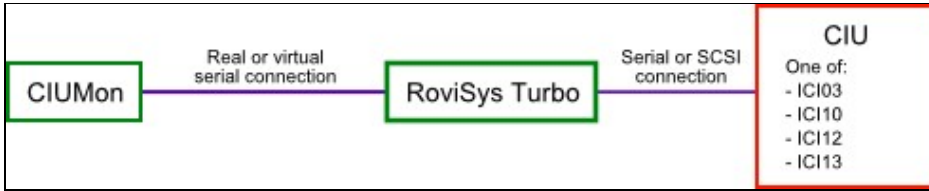

Connecting through RoviSys Turbo also allows a CIU to be shared between CIUMon and other programs, such as WinCAD or Composer.

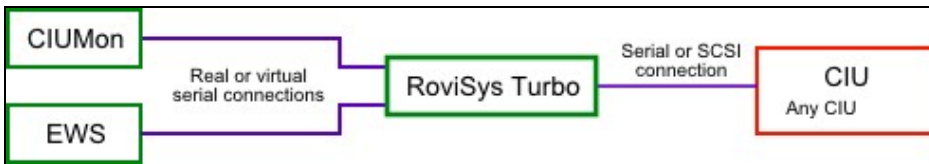

RoviSys Turbo can be connected via **serial port** to an IET800 ethernet CIU. This lets DBDOC take advantage of RoviSys Turbo's turbo mode features. Contact us for instructions on how to set this up.

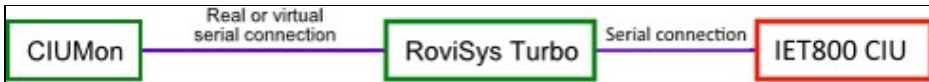

Alternatively, you can create special DBDOC blocks in Harmony OPC Server to allow DBDOC to connect to an IET800 ethernet CIU over your network. (However, because this method does not allow you to use RoviSys Turbo's turbo mode features, it will typically provide less throughput than using RoviSys Turbo to connect either to the ethernet CIU or to another serial or SCSI CIU.)

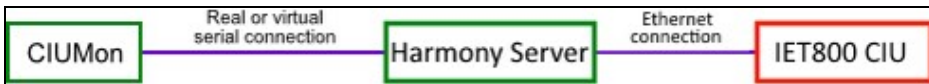

4.3 Connecting to a CIU

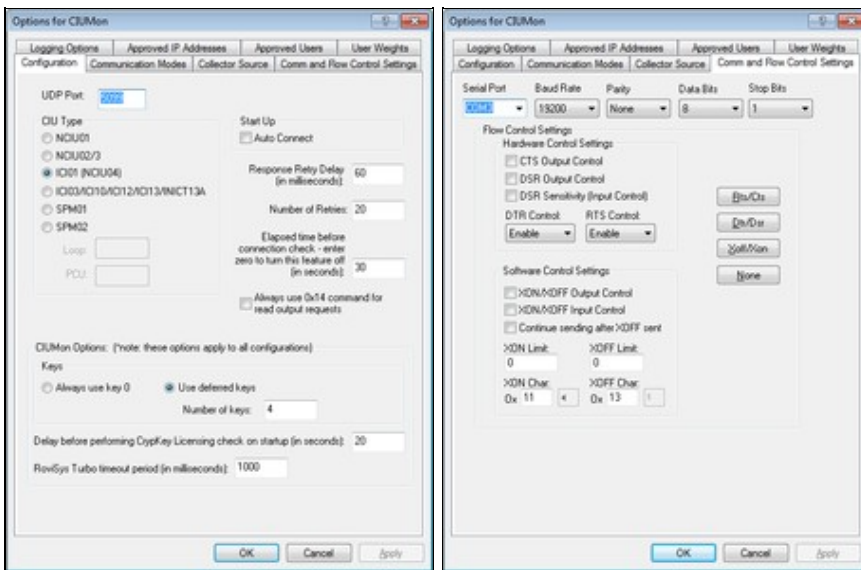

To connect directly to a CIU:

1. On the **Options** menu, click **CIUMon Settings**. Choose a UDP port, and select your CIU type.
2. Click the **Communication Modes** tab, and click **Connect directly through serial port**.
3. Click the **Comm and Flow Control Settings** tab, and select the serial port connected to the CIU in the **Serial Port** list.

Note: If EWS software, such as Composer or WinCAD, is set up on the same computer, then you may wish to move the serial connection to a different COM port. This way you do not have to change any settings in the EWS software, but that software and CIUMon are not trying to access the same port.

4. If you know that any of the other settings need to be changed for your setup, change them now. Usually the defaults are fine.
5. Click **OK** to close the Options window. Then, make sure you can get data from your CIU.

4.3.1 Choosing a port to get data from CIUMon

1. On the **Options** menu, click **Settings**. Click the **Configuration** tab.
2. In the **UDP Port** box, type the UDP port for CIUMon to use.

Note: Usually, the default port 5099 should be used. But if multiple instances of CIUMon will be running on the same computer, they must use different UDP ports. CIUMon will warn you if you try to set a port that matches what is already in another configuration.

3. Make a note of the UDP port that you've chosen. You will need this number in order to configure Hyperview to get live data.
4. Click **OK** to close the **Options** window.

4.3.2 Configuring CIUMon for your CIU type

1. On the **Options** menu, click **CIUMon Settings**. Click the **Configuration** tab.
2. In the **CIU Type** box, click your CIU type.
3. If any of the following special situations apply, change the settings as needed:
 - ◆ If you are connecting to a serial port module (SPM01 or SPM02), type the loop number in the **Loop** box and the PCU number in the **PCU** box. These parameters tell CIUMon which Loop and PCU the serial port module is connected to.

- ◇ CIUMon will send an environment fetch to get the loop and PCU from an SPM02, but the fetched loop and PCU will be meaningless. CIUMon must use the specified loop and PCU to know what requests to send to the serial port module.

4. Click **OK** to close the **Options** window.

4.3.3 Connecting to a TRAX emulator

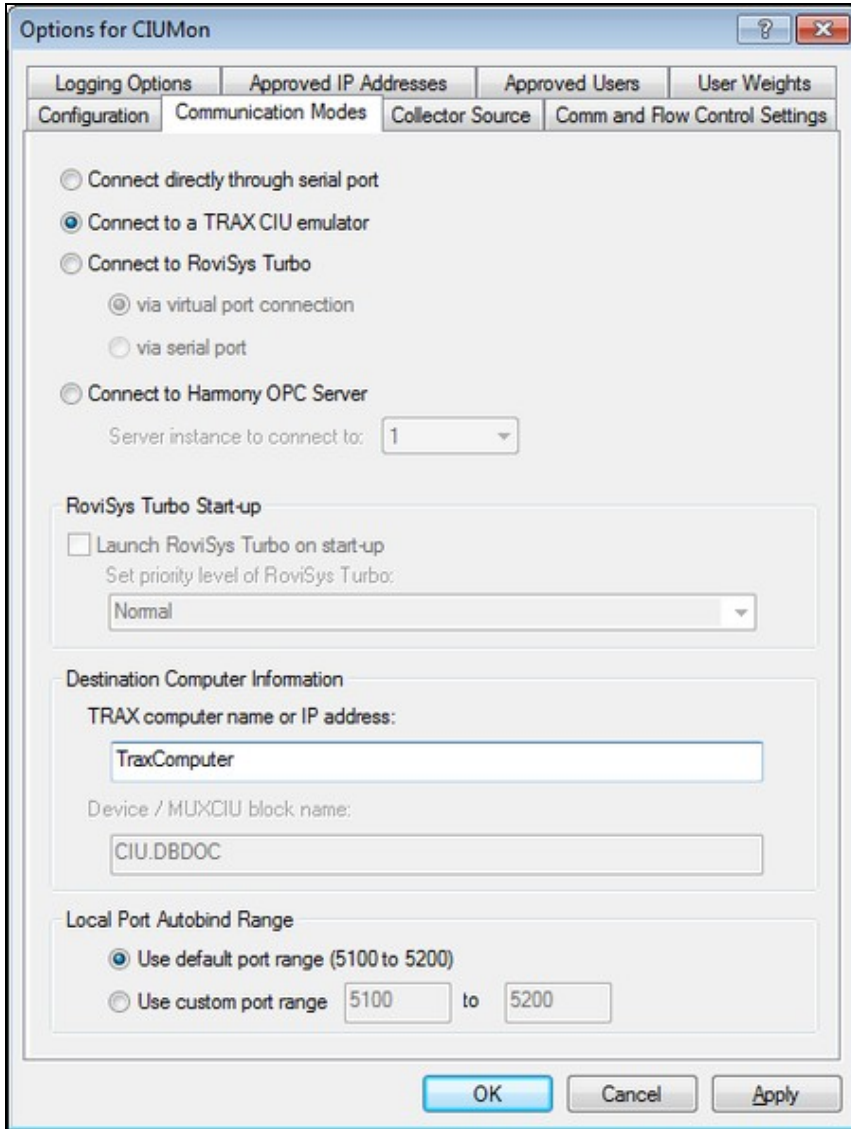

1. On the **Options** menu, click **Settings**.
2. Click the **Communication Modes** tab.
3. Click **Connect to a TRAX CIU emulator**.
4. Type the IP address of the computer running the Trax emulator in the **TRAX computer name or IP address** box.

Note: When you disconnect CIUMon or another program from the Trax emulator, you will need to wait for approximately four minutes before you can connect to the emulator again. This is because of how Trax handles its network sockets.

4.3.4 Making sure you can get data from CIUMon

```

CIUMon - CIUMon Configuration
File Options Help
Confirming instance of VirtualPortSetup
Configuration currently loaded: CIUMon Configuration
Connected
CIUMON Version: w2012-01-04a $
Current Windows Version: Windows Vista Service Pack 2
0 environment from IP Address 0.0.0.0 (port 0) from <Internal>
CIU Environment request: Issuing data request. Please wait...
45 00 45 00
00 08 03 46 4F 01 01 06 04 AC 00
Current Module Type is 8: ICI03/ICI10/ICI12/ICI13/INICT13A
Current Module Mode is 3: CIU03 mode
Firmware revision is F_0
CIU is currently online
CIU: Communicating with CIU, ring 4, node 6, Thu Jan 19 10:49:10 2012
CIU: Time interval 0.045 seconds, maximum 22 fetches per second.
0 cancel from IP Address 0.0.0.0 (port 0) from <Internal>
Cancel Keyed Command request for key <0>: Issuing request. Please wait...
32 00 32 00
00 00 00
0 cancel
OK

```

Transmissions: 2 Errors: 0 Failure rate: 0.000% Port: 5099 Logging to File Log: 1 MB

Once you have configured CIUMon to connect to your CIU, you should test it to make sure your configuration works. The best end-to-end test is to connect Hyperview and make sure you can get data.

1. If the **Options** window is still open, click **OK** to close it.
2. On the **File** menu, click **Connect**. CIUMon should display some information, including your CIU's ring and node. The word "OK" should appear in green, on a line by itself.
3. Using Hyperview, check to make sure you can access live data. See Live Data Configuration in Hyperview and Displaying Slow Mode live data in Hyperview.
4. Once CIUMon is connected to your CIU, you may wish to:
 - ◆ Run CIUMon automatically (as a service)
 - ◆ Build the connection settings into your project

4.3.5 Running CIUMon manually

Most of the time, you should run CIUMon automatically. However, there may be occasions where you need to run it manually.

To run CIUMon manually:

1. Start CIUMon. On the **Start** menu, point to **All Programs**, then point to **GMCL DBDOC**, and then click **Start CIUMon Online Data Server**.
2. If you have more than one configuration, CIUMon will ask you to choose which configuration you want to load. Select the appropriate configuration, and click **OK**.
3. CIUMon may connect automatically, if it is configured to do so. (To configure CIUMon to connect automatically: On the **Options** menu, click **Settings**; and then select "Auto Connect".) If it does not connect automatically, then on the **File** menu, click **Connect**.

 **Note:** If you are running CIUMon as a service, you will not be able to run the same configuration manually unless you stop the service first.

When CIUMon is run manually or interacting with the desktop, you can use the CIUMon menus to interact with CIUMon.

You can use the menus to connect or disconnect from the CIU, clear the displayed messages, check the connection status, or change CIUMon's settings.

To connect to the CIU:

- On the **File** menu, click **Connect**.

To disconnect from the CIU:

- On the **File** menu, click **Disconnect**.

To clear the displayed messages:

- On the **File** menu, click **Clear Window**.

To change CIUMon's settings:

1. On the **Options** menu, click **CIUMon Settings**.
2. Change the settings as needed.
3. To make the changes permanent, save the configuration.

4.4 Connecting to RoviSys Turbo

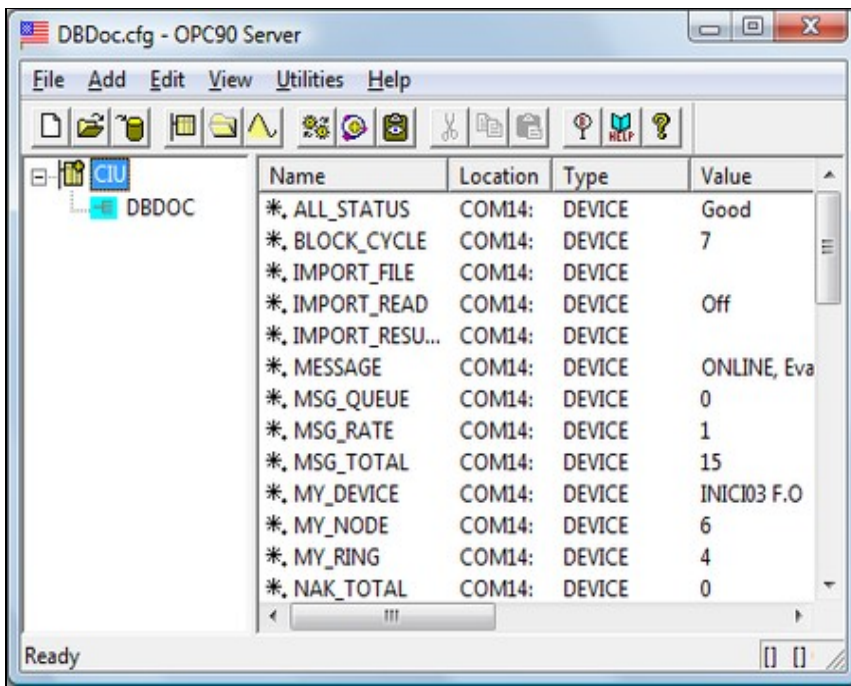

Follow these steps to connect DBDOC to your CIU using RoviSys Turbo:

1. Install RoviSys Turbo on a computer that connects to a CIU.
2. Connect RoviSys Turbo to your CIU.
3. Connect CIUMon to RoviSys Turbo.
4. Set up RoviSys Turbo to accept connections from any programs CIUMon is sharing the CIU with (such as WinCAD or Composer).

Note: These instructions are for RoviSys Turbo version 7.2 or later. If you are using an older version of RoviSys Turbo, we recommend you upgrade. If you must connect CIUMon to an older version of RoviSys Turbo, contact us for instructions.

4.4.1 Installing RoviSys Turbo

A trial version of RoviSys Turbo is included with DBDOC. The installer for the trial version is located in either `C:\Program Files\DBDOC\PROGRAMS\RoviSys\` or `C:\DBDOC\CIUMON\Programs\RoviSys\`, depending on how CIUMon was installed.

Note: The RoviSys Turbo demo will run for up to one hour at a time, and it can be configured to allow for a one-time 45-day trial. The demo on the DBDOC install DVD might not be the most recent version. To get the newest and best version of the demo, download it from <http://www.rovisys.com>. There is a link to the RoviSys Turbo demo download page on <https://www.gmcl.com/downloads.php>.

To continue using RoviSys Turbo, you will need to purchase a license from RoviSys. Please contact us for information. You may also contact RoviSys directly through their web site at <http://www.rovisys.com>.

Note: You may need to uninstall the demo version of RoviSys Turbo when upgrading to the full version. Upgrading to a newer version of RoviSys Turbo may also require you to uninstall the old version. Before uninstalling RoviSys Turbo, we recommend backing up your configuration: in RoviSys Turbo, on the **File** menu, click **Save As** and save a copy of the configuration file to a backup folder.

4.4.2 Connecting RoviSys Turbo to a CIU

1. On RoviSys Turbo's **File** menu, click **Open**. Open DBDOC.cfg, which is in **C:\Program Files\OPC90 Server\CFG** if RoviSys Turbo is installed in the default location.
2. Right-click **CIU** in the left-hand pane, then click **Properties**.
3. In the **Primary Port** list, click the COM or SCSI port that is connected to the CIU.

 **Note:** If you are using RoviSys Turbo on a computer with EWS software, you might want to move the CIU to a different port to avoid changing the EWS software configuration.

4. Make any other changes you need, in order configure how RoviSys Turbo communicates with your CIU. Click **OK**.
5. If the CIU is connected to a COM port, set up that port. On the **Edit** menu, click **Ports**. In the **Port** list, click the port that is connected to the CIU. Set the baud rate and other settings to match the CIU. Click **OK**.

 **Note:** RoviSys Turbo ports default to 19200 Baud with other settings that are normally correct.

6. If you want to log data, right-click CIU and select each of the first four logging options.
7. On the **File** menu, click **Save**.

 **Note:** If you are using RoviSys Turbo on a computer with User Account Control (UAC) enabled, you may not be able to save the configuration in the default folder. Choose another folder in which to save the configuration.

8. Start the connection to the CIU to make sure it works: on the **View** menu, click **Monitor**. After a moment, the text "CIU: ONLINE" will appear in the RoviSys Turbo status bar. You must see **MyRing** and **MyNode** having non-zero values, except for Plant Loop, in which case **MyRing** will be zero.

To configure RoviSys Turbo's communications with your CIU:

- In RoviSys Turbo, right-click **CIU** in the left-hand pane, then click **Properties**. The **Device Properties** window appears.

For most people using DBDOC, we recommend that you:

- Change the **Import exception report request rate** to **60000 ms**, unless you are using OPC tags.
- Select the **Enable Turbo Polling** check box.
- Select the **Non-keyed output polling** check box.
- Select the **Enhanced Analog Precision** check box.

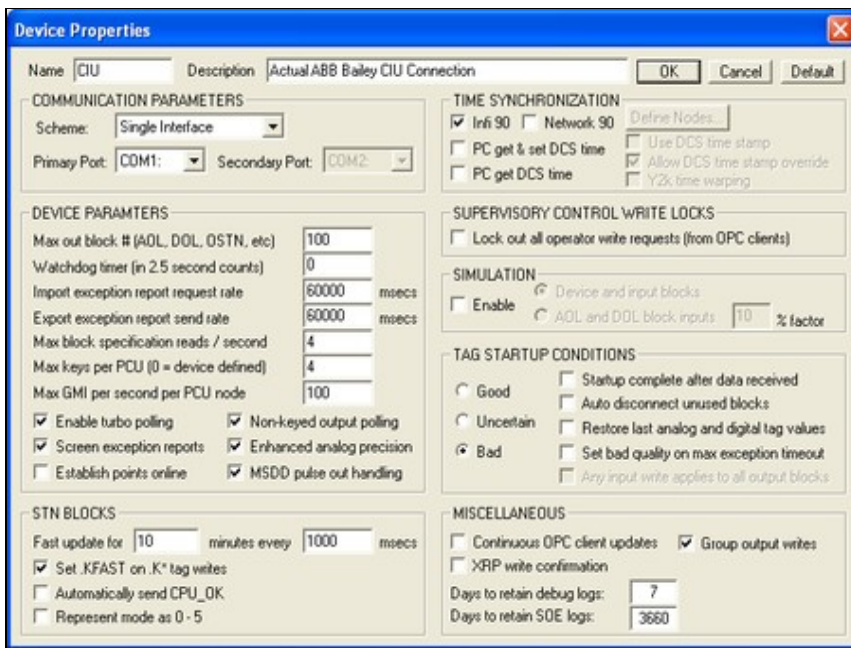

Normally, programs like Composer and DBDOC must get data from your system one block at a time, but "turbo mode" allows RoviSys Turbo to fetch multiple blocks at once. Using turbo mode, you can get data more quickly, while reducing the load on your system.

If you are having problems getting data with turbo mode, please contact us for help. We will work with RoviSys to make sure that you can get data reliably while benefiting from turbo mode's higher speeds and reduced load on your system. Meanwhile, to make sure that you are always able get data, you can temporarily disable turbo mode.

To disable turbo mode:

- Clear the **Enable Turbo Polling** box.

To enable turbo mode:

- Select the **Enable Turbo Polling** box.

Depending on how much data is being asked for, RoviSys Turbo can make multiple requests for data at once by using different "keyed" requests. However, you can usually get data more quickly if RoviSys Turbo is making only one request at a time. So, for most situations, we recommend setting RoviSys Turbo to make only one request at a time by selecting the **Non-keyed output polling** box.

4.4.3 Methods of connecting CIUMon to RoviSys Turbo

There are two ways to connect CIUMon and RoviSys Turbo:

- **RoviSys Turbo virtual ports** are easy to set up and provide high data rates. If RoviSys Turbo and CIUMon are on different computers, they can still be connected with RoviSys Turbo virtual ports through the network. RoviSys Turbo virtual ports require RoviSys Turbo 7.2 or newer and CIUMon 10.4 or newer.
- **Serial ports** are generally harder to set up and slower. Some system managers may choose to use serial ports if RoviSys Turbo and CIUMon are on different computers, in order to keep OPC data off the network. Serial ports can also be used with older versions of RoviSys Turbo and CIUMon.

4.4.4 Connecting to RoviSys Turbo with virtual ports

To connect CIUMon to RoviSys Turbo by using RoviSys Turbo virtual ports:

1. Configure the virtual ports in RoviSys Turbo
2. Set up CIUMon to connect to the RoviSys Turbo virtual ports

To set up RoviSys Turbo:

Edit Existing OPC90 Block

Name:

Description:

Block Type:

ADDRESSING

Port:

Read only Allow R4 Prefetch
 Virtual port No turbo

Analog Output Parameters

Sig. Change: %
EU Code:
Init Value:
Zero:
Span:
Lo Alarm:
Hi Alarm:
Dev Lim:
STN Type:

Digital Output Parameters

Initial Value:
Alarm State:
Faceplate Type Code:

Exception Report Outputs

Max Time: seconds

Poll Block Parameter

Poll Interval: milliseconds

Logic State Descriptors

	Zero State	One State	State 0	State 0
Output	<input type="text" value="Off"/>	<input type="text" value="On"/>	<input type="text" value="State 0"/>	<input type="text" value="State 0"/>
Feedback 1	<input type="text" value="Off"/>	<input type="text" value="On"/>	<input type="text" value="State 1"/>	<input type="text" value="State 1"/>
Feedback 2	<input type="text" value="Off"/>	<input type="text" value="On"/>	<input type="text" value="State 2"/>	<input type="text" value="State 2"/>
Feedback 3	<input type="text" value="Off"/>	<input type="text" value="On"/>	<input type="text" value="State 3"/>	<input type="text" value="State 3"/>
Feedback 4	<input type="text" value="Off"/>	<input type="text" value="On"/>		
Permissive 1	<input type="text" value="Off"/>	<input type="text" value="On"/>		
Permissive 2	<input type="text" value="Off"/>	<input type="text" value="On"/>		

1. In RoviSys Turbo, stop the connection to the CIU: on the **View** menu, clear the **Monitor** check mark.
2. Expand **CIU** in the left-hand pane. Right-click **DBDOC**, then click **Properties**.
3. In the **Addressing** box, select **Virtual port**.
4. In the **Port** list, select a different port from the one the CIU is using.
5. Select **Read only** and **Allow R4**. Ensure that **Prefetch** is *not* selected.
6. Click **OK**.
7. On the **File** menu, click **Save**. Then, start the connection to the CIU: on the **View** menu, click **Monitor**.

To set up CIUMon:

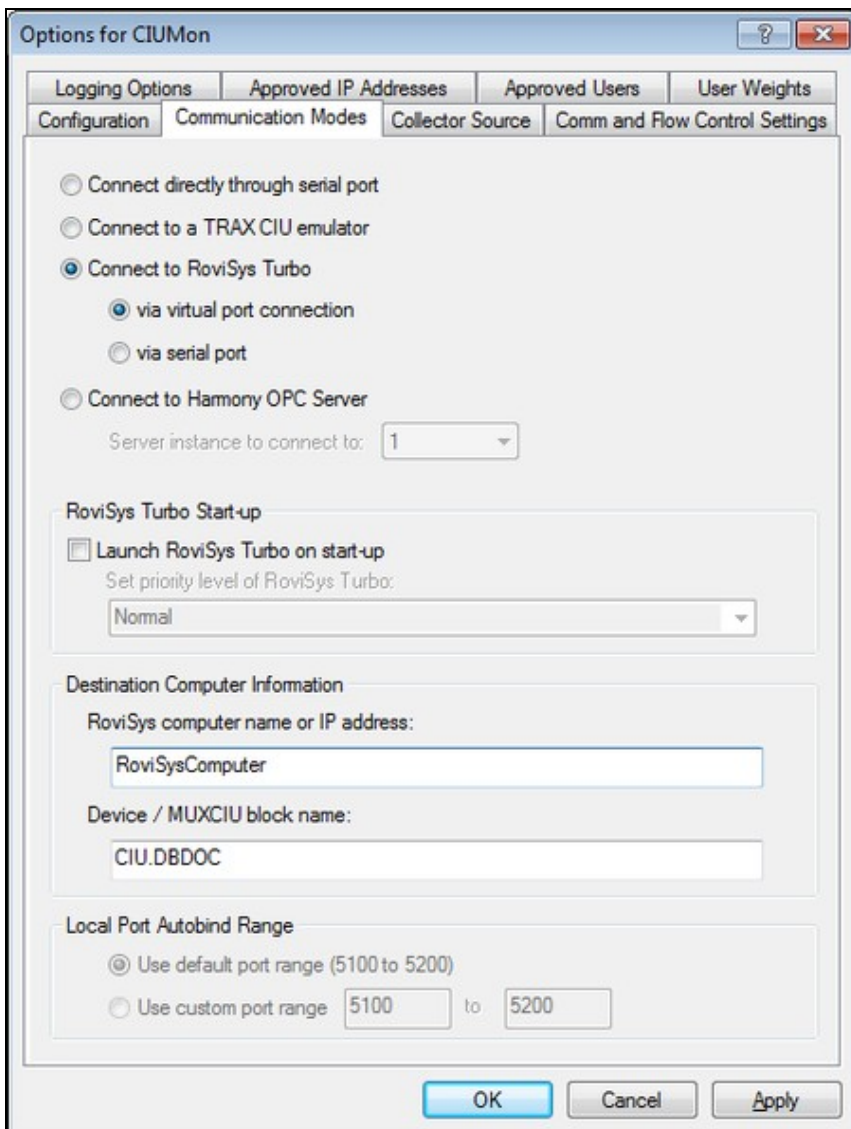

1. On CIUMon's **Options** menu, click **Settings**. Choose a UDP port, and select your CIU type.
2. Click the **Communication Modes** tab. Select **Connect to RoviSys Turbo** and **via virtual port connection**.
3. Type the IP address or hostname of the computer running RoviSys Turbo in the **RoviSys computer name or IP address** box.
4. If you changed the name of the **CIU** or **DBDOC** blocks in RoviSys Turbo's left hand pane, change the **Device / MUXCIU block name** box to match.
5. If you know that any of the other settings need to be changed for your setup, change them now. Usually the defaults are fine.
6. Click **OK** to close the Options window. Then, make sure you can get data from your CIU.

4.4.5 Connecting to RoviSys Turbo with serial ports

To connect CIUMon to RoviSys Turbo by using serial ports:

1. Set up a pair of serial ports on your computer
2. Configure RoviSys Turbo to provide data to one port
3. Configure CIUMon to connect to the other port

To set up the serial ports:

1. If RoviSys Turbo is running, exit RoviSys Turbo: on the **File** menu, click **Exit**.
2. Connect two serial ports with a null-modem cable for CIUMon and RoviSys Turbo to communicate with each other through. RoviSys Turbo will connect to one of these ports, and CIUMon will connect to the other.
3. Write down which ports you set up and which program you plan to connect to each of them.

Notes:

- ◆ Very old versions of RoviSys Turbo cannot connect to serial ports above COM9, but you can use low port numbers for RoviSys Turbo and higher ones for CIUMon in that case.
- ◆ If RoviSys Turbo and CIUMon are on the same computer, and it does not have a 64-bit operating system, you can use virtual serial ports.
- ◆ If RoviSys Turbo and CIUMon are on different computers or on a computer with a 64-bit operating system, and there are not enough serial ports, you can add more ports with an internal interface card or a usb-to-serial converter. Alternately, you can use a third-party virtual serial port program.

To set up RoviSys Turbo:

Edit Existing OPC90 Block X

Name: OK Cancel

Description:

Block Type:

ADDRESSING

Port: Read only Allow R4 Prefetch
 Virtual port No turbo

Analog Output Parameters

Sig. Change: %

EU Code:

Init Value:

Zero:

Span:

Lo Alarm:

Hi Alarm:

Dev Lim:

STN Type:

Digital Output Parameters

Initial Value:

Alarm State:

Faceplate Type Code:

Exception Report Outputs

Max Time: seconds

Poll Block Parameter

Poll Interval: milliseconds

Logic State Descriptors

	Zero State	One State		
Output	<input type="text" value="Off"/>	<input type="text" value="On"/>	State 0	<input type="text" value="State 0"/>
Feedback 1	<input type="text" value="Off"/>	<input type="text" value="On"/>	State 1	<input type="text" value="State 1"/>
Feedback 2	<input type="text" value="Off"/>	<input type="text" value="On"/>	State 2	<input type="text" value="State 2"/>
Feedback 3	<input type="text" value="Off"/>	<input type="text" value="On"/>	State 3	<input type="text" value="State 3"/>
Feedback 4	<input type="text" value="Off"/>	<input type="text" value="On"/>		
Permissive 1	<input type="text" value="Off"/>	<input type="text" value="On"/>		
Permissive 2	<input type="text" value="Off"/>	<input type="text" value="On"/>		

1. Start RoviSys Turbo.
2. Expand **CIU** in the left-hand pane. Right-click **DBDOC**, then click **Properties**.
3. In the **Port** list, click the port that you set up for RoviSys Turbo. Select **Read only** and **Allow R4**. Click **OK**.
4. On the **Edit** menu, click **COM Ports**. In the **Port** list, click the port that RoviSys Turbo was set to use in the previous step. Set the baud rate to **57600**. Click **OK**. **115200** is overly vulnerable to ambient interference and should not be used.
5. On the **File** menu, click **Save**. Then, start the connection to the CIU: on the **View** menu, click **Monitor**.

To set up CIUMon:

The screenshot shows the 'Options for CIUMon' dialog box with the following settings:

- Logging Options**: Configuration
- Approved IP Addresses**: Communication Modes
- Approved Users**: Collector Source
- User Weights**: Comm and Flow Control Settings
- Connect to RoviSys Turbo** (selected)
 - via virtual port connection
 - via serial port** (selected)
- Connect to Hamony OPC Server**
 - Server instance to connect to: 1
- RoviSys Turbo Start-up**
 - Launch RoviSys Turbo on start-up
 - Set priority level of RoviSys Turbo: Normal
- Destination Computer Information**
 - RoviSys computer name or IP address: RoviSysComputer
 - Device / MUXCIU block name: CIU.DBDOC
- Local Port Autobind Range**
 - Use default port range (5100 to 5200)
 - Use custom port range: 5100 to 5200

Buttons: OK, Cancel, Apply

1. On CIUMon's **Options** menu, click **CIUMon Settings**. Choose a UDP port, and select your CIU type.
2. Click the **Communication Modes** tab. Select **Connect to RoviSys Turbo** and **via serial port**. (**Connect directly through serial port** can be used instead, but there is some loss of performance using that option.)
3. Click the **Comm and Flow Control Settings** tab. Select the serial port you set up earlier for CIUMon in the **Serial Port** list. In the **Baud Rate** list, click the baud rate of the serial port connected to the CIU.

Note: If you are using virtual serial ports, this setting doesn't matter.

4. If you know that any of the other settings need to be changed for your setup, change them now. Usually the defaults are fine.
5. Click **OK** to close the Options window. Then, make sure you can get data from your CIU.

4.4.6 Adding serial ports to your computer

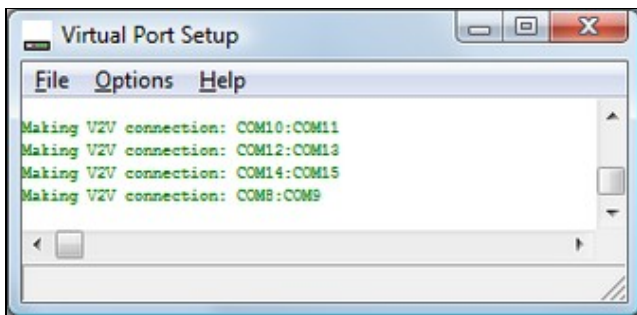

RoviSys Turbo may connect to CIUMon or your EWS software through a serial line. To do so, RoviSys Turbo and the other program must each have a COM port, and these ports must be connected. In many cases, if RoviSys Turbo and the other program are running on the same computer, they can connect through virtual serial ports rather than real serial ports.

- Instead of using serial ports, CIUMon can connect to RoviSys Turbo using RoviSys Turbo virtual ports.
- On 32-bit platforms, you can connect your EWS software to RoviSys Turbo using virtual serial ports included with DBDOC.
- The included virtual serial ports do not work on 64-bit Windows platforms (including Windows 7). To add serial ports to one of these platforms, use a usb-to-serial converter, or better, use internal serial ports on the motherboard or install a PCI serial card. Alternately, you can use a third-party virtual serial port program.

To set up virtual serial ports:

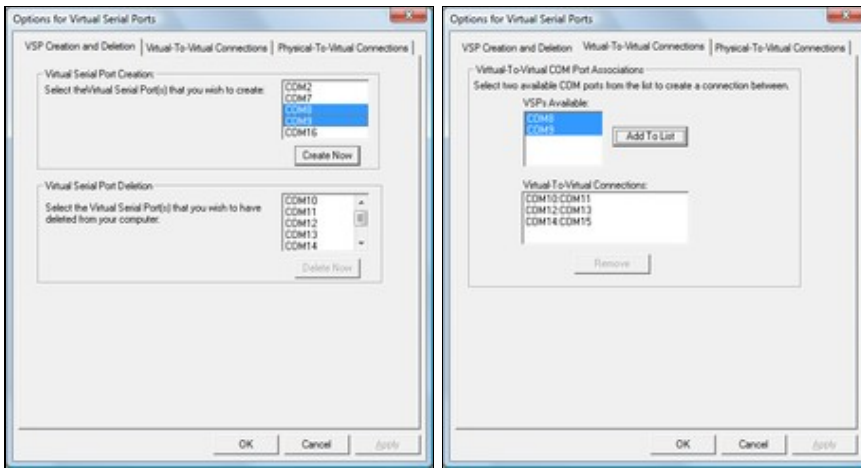

1. On the CIUMon **Options** menu, click **Virtual Serial Port Setup**. The Virtual Port Setup program will open.
2. On the Virtual Port Setup **Options** menu, click **VSP Configuration**.
3. In the **Virtual Serial Port Creation** list, click any port. Hold down CTRL and click a second port. Click **Create Now**. The two ports that were selected will disappear from the **Virtual Serial Port Creation** list and appear in the **Virtual Serial Port Deletion** list.
4. Click the **Virtual-To-Virtual Connections** tab.
5. In the **VSPs Available** list, click the first port, then click the second port. Click **Add To List**. The two ports will disappear from the **VSPs Available** list, and the new connection will appear in the **Virtual-To-Virtual Connections** list.

Note:

- The **Virtual Serial Port Setup** option is disabled on 64-bit Windows platforms (including Windows 7). Also, they do not work on Windows 8. To add serial ports to 64-bit Windows, use a usb-to-serial converter. Alternately, you can use a third-party virtual serial port program.
- If you have not run Virtual Port Setup before, it will be installed when you try to run it. You will then be prompted to reboot the computer.
- The first time you set up and try to use virtual serial ports after installing them and rebooting the computer, you may see an **Error: COMx.Read (), code 87** message in the Virtual Port Setup window. If this occurs, reboot your computer again -- the virtual serial ports should work fine after this second reboot.
- If you get a **Could not find OEM file** error after your computer reboots, copy the file "vsp.oem" from the folder where CIUMon is installed to the system32 subfolder of your computer's Windows folder.
- If you later install more physical serial ports, you should delete all of the virtual serial ports and connections first, then re-create them after the new physical ports are installed and working.

To remove virtual serial ports:

1. In **Windows Explorer**, browse to the Programs folder in your installation directory (this is usually in either C:\Program Files\GMCL\DBDOC or C:\DBDOC\CIUMON).
2. Double-click VSPCleanup.exe and follow the instructions.
3. If the computer was not rebooted in the previous step, reboot it now.

To set up internal serial ports:

1. If you are installing a new interface card to add serial ports, you will have to power down the computer and open it up. Identify an unused slot of the type required by the card and remove the corresponding cover from the back of the case. Depending on the number of ports supported by the card, you may also have to connect a *serial port header* to the card and install it in another unused opening in the back of the case.
2. Identify the serial ports you've installed:
 1. Right-click the **My Computer** icon on the desktop, and then click **Properties**.
 2. Click the **Hardware** tab, then click the **Device Manager** button.
 3. Expand the **Ports (COM & LPT)** entry. The serial ports should each be listed as **Communications Port (COMn)** or **mumble Serial Port (COMn)**, where *n* is the port number and *mumble* is some descriptive text.
3. Connect two ports with a null modem cable, to provide a connection between them.

To set up a usb-to-serial converter:

1. Plug the converter into an available USB port on your computer.

After a short delay, Windows will recognize and install the converter. When it has finished installing the converter, it will display a message in the system tray.

2. Check that it is installed correctly:
 1. Right-click the **My Computer** icon on the desktop, and then click **Properties**.
 2. Click the **Hardware** tab, then click the **Device Manager** button.
 3. Expand the **Ports (COM & LPT)** entry. The new serial ports should each be listed as **USB Serial Port (COMn)**, where *n* is the port number.
3. Connect two ports with a null modem cable, to provide a connection between them.

 **Note:** GMCL has USB-to-serial converters available for sale. Please contact us for details.

A note about USB-to-serial converters and Windows 7:

On Windows 7 and Windows 2008 Server, USB-to-serial converters do not work as well as internal serial ports. They are slower and have higher error rates. In some cases, they may not work at all. You should use internal serial ports if possible. Alternately, you can use a third-party virtual serial port program.

If you do use USB-to-serial converters on Windows 7 and 2008 Server, do not use speeds above 115200 bps.

If Windows 7 or Windows 2008 Server does not automatically install your USB-to-serial converter, you will need to download drivers from the converter manufacturer's website. The drivers for the USB-to-serial converters sold by GMCL are available at http://www.vscom.de/616_download.htm.

Third-party virtual port alternatives:

As an alternative to RoviSys Turbo virtual ports, the virtual serial port software included with DBDOC, or physical serial ports, you can use a third-party virtual serial port program to connect CIUMon or your EWS software to RoviSys Turbo.

These software packages can create virtual serial ports for CIUMon or your EWS software to use for connecting to RoviSys Turbo:

- The com0com null-model emulator is an open source virtual serial port driver that supports both 32-bit and 64-bit versions of Windows. Note that to use this program with 64-bit Windows, you will need a signed version of the com0com driver. Contact us for information about obtaining a signed

version of the driver.

- The Eltima Virtual Serial Port Driver is a commercial software package that can create virtual serial ports. It supports both 32-bit and 64-bit versions of Windows.

4.4.7 Connecting other programs to RoviSys Turbo

If you are using RoviSys Turbo to share a serial connection to a CIU between CIUMon and EWS software (such as Composer or WinCAD), you can avoid changing the EWS software settings with the following strategy:

1. Move the CIU connection to a different serial port, and connect RoviSys Turbo to that serial port.
2. When you set up RoviSys Turbo to accept connections from the EWS software, connect a null cable between the serial port that the CIU was connected to and a third serial port.
3. Then, have RoviSys Turbo use the third serial port to communicate with the EWS software. The EWS software will connect to RoviSys Turbo through the null cable, using the same port as before.

A side benefit of this approach is that you can reconnect the CIU directly to the EWS simply by moving the cable back. If the computer does not have the extra serial ports you need for this approach, you can add serial ports with an internal interface card or a usb-to-serial converter.

To connect other programs to RoviSys Turbo:

1. If RoviSys Turbo is running, exit RoviSys Turbo: on the **File** menu, click **Exit**.
2. Set up two connected (real or virtual) serial ports for RoviSys Turbo and the other program to communicate with each other through. Write down the two port numbers. RoviSys Turbo will connect to one of these ports, and the other program will connect to the other one.

 **Note:** If you moved the CIU connection so you wouldn't have to change settings in the EWS software, then use a connection between the serial port it was originally using and another real serial port.

3. Start RoviSys Turbo and open the saved configuration.
4. Right-click **CIU** in the left-hand pane, then click **New Block**.
5. Type a name for the block in the **Name** box (e.g. WinCAD).
6. In the **Block Type** list, click **MUXCIU**.
7. In the **Port** list, click the port that you set up for RoviSys Turbo. Click **OK**.
8. On the **Edit** menu, click **Ports**. In the **Port** list, click the port that you set up for RoviSys Turbo again. Set a baud rate that your EWS software supports (typically **19200**). Click **OK**.
9. Start the connection to the CIU: on the **View** menu, click **Monitor**.
10. Set up the other program to connect to the port you set up for it.

 **Note:** WinCAD and Composer have been tested to work when connected to a RoviSys Turbo MUXCIU block as described here. Conversely, while S+ Engineering tools may have basic functionality, some functions such as firmware and program downloads will not work, and so RoviSys does not officially support connecting to S+ Engineering tools in this way. Therefore, if you have the option it would be best practice to have a separate, dedicated CIU to use with S+ Engineering tools instead of attempting to multiplex it with DBDOC using RoviSys Turbo.

4.5 Connecting to Harmony OPC Server

DBDOC can connect to HAOPC 6.0 or later. This can allow you to get data from an IET800 ethernet CIU. To do this:

1. Configure the Harmony OPC Server by adding three DBDOC tags. To do this, you will:
 - ◆ Generate Harmony OPC backup configuration files
 - ◆ Modify those files by adding three DBDOC tags
 - ◆ Upload your changes to the configuration
2. Set up CIUMon to connect to the Harmony OPC Server.

Generate backup configuration files:

You will need to edit your Harmony OPC backup configuration files in order to add DBDOC tags. If you do not already have these configuration files, use these steps to generate them.

1. Start the **HOPC Online Utility**: On the **Start** menu, under **Programs**, click **ABB Symphony Plus**, then click **Harmony OPC**, and then click **HOPC Online Utility**.
2. In the **HOPC Online Utility** window, on the **Configuration** menu, click **Backup Configuration**. Choose a folder where you would like to save the backup configuration files.
3. When the backup completes, click **OK**. Then, close the **HOPC Online Utility** program.

Add DBDOC tags to your configuration files:

1. Start the **HOPC Offline Utility**: On the **Start** menu, under **Programs**, click **ABB Symphony Plus**, then click **Harmony OPC**, and then click **HOPC Offline Utility**. Then, on the **File** menu, click **Load** and choose to load the backup configuration files that you previously saved.
2. Add tags to your configuration: On the **Edit** menu, click **Add**. You will need to add three tags:
 - ◆ A tag with the **Tag Type** "BLOCKOUTPUT" and **Tag Name** "DBDOC_OUTPUT", for loop 0, node 0, module 0, block 1.

The screenshot shows the 'Modify HOPC Tag' dialog box. The 'Tag Type' is set to 'BLOCKOUTPUT'. Under 'General Tag Information', the 'Tag Name' is 'DBDOC_OUTPUT' and the 'Tag Desc' is 'STANDARD BLOCKOUTPUT'. The 'Loop (0:250)' is 0, 'Node (0:250)' is 0, 'Module (0:31)' is 0, and 'Block (1:31998)' is 1. In the 'BLOCKOUTPUT' section, 'Infi Address Lock' is unchecked, 'Scan Startup State' is 'Reading On', and 'Client Triggered' is checked.

- ◆ A tag with the **Tag Type** "BLOCKTUNE" and **Tag Name** "DBDOC_TUNE", for loop 0, node 0, module 0, block 1.

The screenshot shows the 'Modify HOPC Tag' dialog box. The 'Tag Type' is set to 'BLOCKTUNE'. Under 'General Tag Information', the 'Tag Name' is 'DBDOC_TUNE' and the 'Tag Desc' is 'STANDARD BLOCKTUNE'. The 'Loop (0:250)' is 0, 'Node (0:250)' is 0, 'Module (0:31)' is 0, and 'Block (1:31998)' is 1. In the 'BLOCKTUNE' section, 'Infi Address Lock' is unchecked, 'Scan Startup State' is 'Reading On', 'Tune Startup State' is 'Specs Read Only', 'Tune Inhibit' is 'On', and 'Client Triggered' is checked.

- ◆ A tag with the **Tag Type** "BLOCKMODSTATUS" and **Tag Name** "DBDOC_MODSTAT", for loop 0, node 0, module 0, block 0.

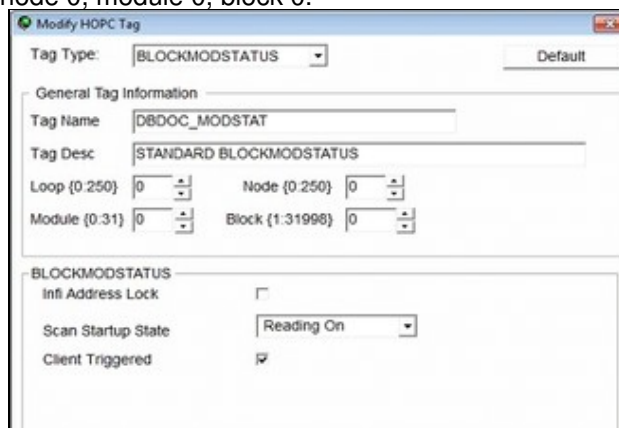

3. After adding the three tags, click the **Verify** button to make sure the changes are valid.
4. Click the **Save** button to save these tags. Then, click **Exit**.

Upload your changes to the configuration:

1. Start the **HOPC Online Utility**: On the **Start** menu, under **Programs**, click **ABB Symphony Plus**, then click **Harmony OPC**, and then click **HOPC Online Utility**.
2. On the **Tools** menu, click **Apply Tag Configuration**. Load the backup configuration file that you modified by adding the three DBDOC tags.
3. Click the **Verify** button. The HOPC Online Utility should show that three changes are detected. Then, click **Apply** to load and merge your changes onto the HOPC server.
4. Close the **HOPC Online Utility** program.

Set up CIUMon to connect to Harmony OPC Server:

1. In CIUMon, on the **Options** menu, click **Settings**.
2. Click the **Communication Modes** tab. Select **Connect to Harmony OPC Server**.
3. Select the appropriate server instance for CIUMon to connect to.
4. Type the IP address or hostname of the computer running Harmony OPC Server in the **Harmony OPC computer name** box.
5. Click **OK** to close the Options window. Then, make sure you can get data from your CIU.

Options for CIUMon

Logging Options | Approved IP Addresses | Approved Users | User Weights
Configuration | Communication Modes | Collector Source | Comm and Flow Control Settings

Connect directly through serial port
 Connect to a TRAX CIU emulator
 Connect to RoviSys Turbo
 via virtual port connection
 via serial port
 Connect to Hamony OPC Server
 Server instance to connect to: 1

RoviSys Turbo Start-up
 Launch RoviSys Turbo on start-up
Set priority level of RoviSys Turbo:
Normal

Destination Computer Information
Harmony OPC computer name:
Harmonious
Device / MUXCIU block name:
CIU.DBDOC

Local Port Autobind Range
 Use default port range (5100 to 5200)
 Use custom port range 5100 to 5200

OK Cancel Apply

4.6 Managing CIUMon configurations

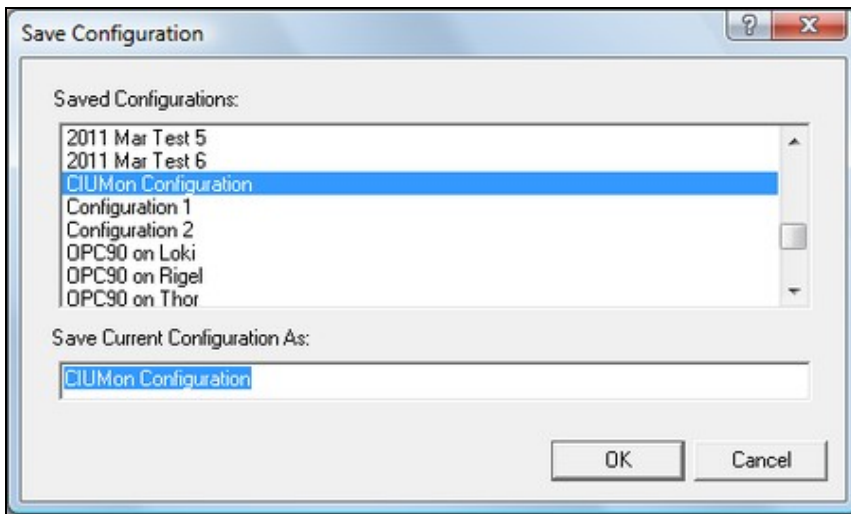

CIUMon can store different configurations. This is especially useful if the computer running CIUMon is connected to multiple CIUs, since it allows a separate configuration to be stored for each CIU. These configurations can be used to run multiple copies of CIUMon connecting to different CIUs, or to change which CIU a single copy of CIUMon is connected to.

Current versions of CIUMon store configurations in the registry. Older versions of CIUMon stored settings in a file in the Windows directory. The first time a newer version of CIUMon is run, it will convert old settings to a configuration called "Configuration 1", which will be loaded automatically.

On startup, CIUMon will attempt to load the configuration that was opened last. If that configuration is already in use, it will open the CIUMon Configurations window so that you can select another configuration.

To keep your configurations organized, use CIUMon's configuration management tool to identify unused configurations that can be hidden or deleted.

4.6.1 Loading, saving, and deleting configurations

To save a configuration:

1. On the **File** menu, click **Save Configuration**.
2. In the "Save Current Configuration As" box, type a name for the configuration.
3. Click **OK**.

To load a configuration:

1. On the **File** menu, click **Load Configuration**.
2. In the **Select the configuration that you wish to load** box, click the configuration to load. Or, click **(New DCS Configuration)** to load CIUMon's default settings for connecting to a CIU. Use **(New Relay Configuration)** only if you are setting up CIUMon in relay mode or collector mode.
3. To see what settings are in the configuration before loading it, click **Preview Settings**.
4. Click **OK**.

To delete a configuration:

1. On the **File** menu, click **Delete Configuration**.
2. In the **Select the configuration that you wish to delete** box, click the configuration you want to delete. You can select several configurations to delete at the same time.
3. To see what settings are in the configuration before deleting it, click **Preview Settings**.
4. Click **Delete**.

Note: If you delete the currently loaded configuration, you will be prompted to confirm first. After closing the dialog, you will be prompted to choose another configuration to load.

Note: You can also use CIUMon's configuration management tool to delete configurations.

4.6.2 Keeping your configurations organized

Use CIUMon's configuration management tool to keep your configurations organized, by identifying unused configurations and hiding or deleting them.

To use this tool: On the **File** menu, click **Manage Configurations**.

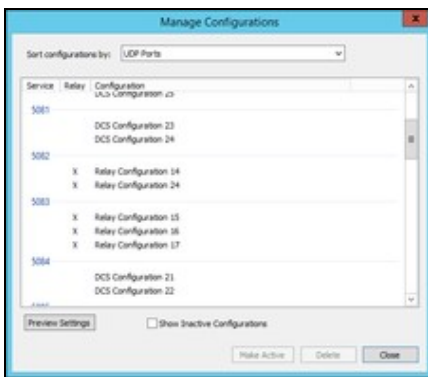

To identify unused configurations:

Each UDP port and serial COM port on your computer can only connect to one program at a time. So, if you have two CIUMon configurations that are both using the same UDP port or COM port, you cannot use them both at once. Usually, in this situation, one of the configurations will be the one you are currently using, while the other is unused: for example, the unused configuration might be an old configuration that is no longer relevant, or it might simply have been created by accident.

To identify configurations that share a UDP or COM port: In the **Sort configurations by** box, select one of the following.

- **UDP Ports.** This will show you which configurations are using each port to receive requests for data. You can easily see if there are multiple configurations that all use the same port. Since every CIUMon configuration must use a UDP port to receive requests, all of your configurations will appear somewhere in this list.
- **Serial COM ports.** This will show you which configurations use each COM port to communicate with the CIU. Some configurations may not use COM ports ? for example, you might have configurations that connect to a TRAX emulator, to a Harmony OPC server, or to RoviSys Turbo by using a virtual connection. These configurations will not appear in the list when you choose to sort by **Serial COM ports**.
- **Collector Ports.** This will show you which collector receiver configurations are using each port to listen for data from the upstream CIUMon. Only relay configurations that are set up as collector receivers will appear in this list.

- **Serial Port Module Loop/PCU.** If you have configurations configured to connect to a serial port module (SPM01 or SPM02), this will show you which configurations are set up for each loop and PCU.
- **Configurations with/without conflicts.** This will show you all of the configurations that share a UDP port, COM port, collector port, or serial port module loop/PCU with some other configuration. Click **Preview Settings** or double-click on any configuration to see exactly what is being used and by which configurations.
- **Configurations with/without services.** Configurations that are actively in use may have services set up to run them automatically. So, the configurations without services displayed in this list are more likely to be unused.

If you have two or more configurations that share a UDP or COM port, only one of those configurations will be able to connect at a time. So, the others might be unused. Use these techniques to determine which configurations are unused.

- To view the settings for any configuration: Click **Preview Settings**; or double-click on the configuration. The preview window displays all of the options for the configuration, as well as a list of other configurations that share a COM or UDP port.
- Use the "Service" column in the list to see which configurations have services set up to run them automatically. Configurations that have services associated with them are also displayed in green. Configurations without services might be more likely to be unused.

To hide or delete unused configurations:

- **To hide unused configurations.** Click on the configuration you want to hide, and click **Make Inactive**. You can hold down shift or ctrl to select multiple configurations and hide them all at the same time. CIUMon will not load inactive (hidden) configurations and you will not see them in the Save Configuration or Load Configuration windows, but you can restore them if you would like to use them again.
- **To view inactive configurations.** Select the **Show Inactive Configurations** box. You can identify which configurations are inactive by using the **Inactive** column in the list. Inactive configurations will also be displayed in grey. Alternatively, in the **Sort configurations by** box, select **Active/Inactive Configurations** to get a list of all inactive configurations.
- **To restore inactive configurations.** Select the configuration you want to restore and click **Make Active**.
- **To permanently delete unused configurations.** Click on the configuration you want to delete, and click **Delete**. You can hold down shift or ctrl to select multiple configurations and delete them all at the same time.

4.7 Getting live data across a network

DBDOC can provide read-only live data across most network setups.

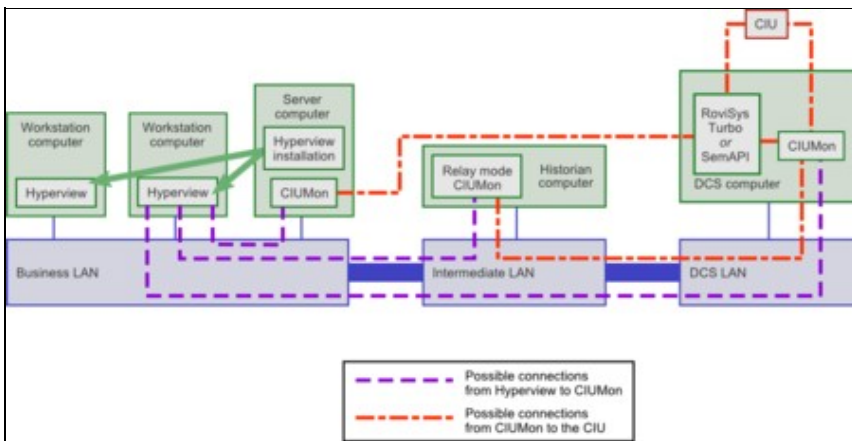

4.7.1 Getting live data through a firewall

By default, CIUMon listens on UDP port 5099. In order to connect to CIUMon from across a firewall, this port must be unblocked to allow UDP communication.

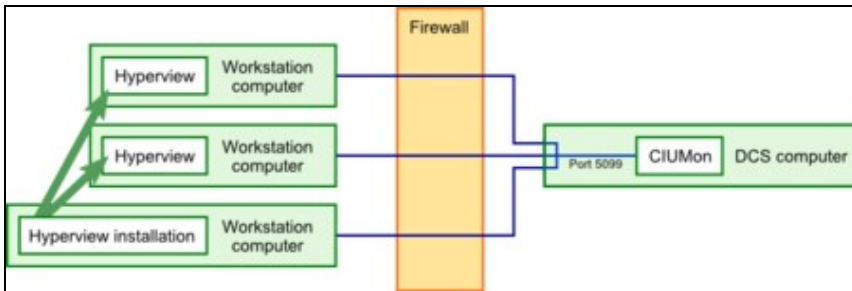

To avoid having user connections that must be allowed through the firewall, CIUMon can be run in relay mode or collector mode on a computer outside the firewall. This CIUMon connects to the main CIUMon through the firewall, and live data users connect to the relay or collector mode CIUMon.

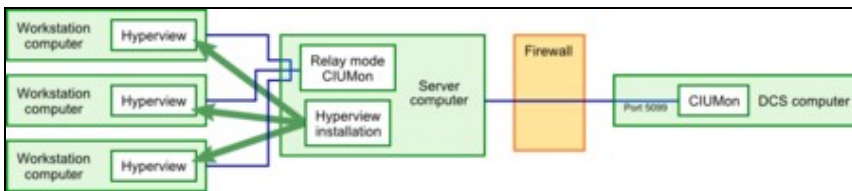

If your firewall rules require the upstream CIUMon to initiate all communications, you may use collector mode instead of relay mode. As in relay mode, CIUMon will accept requests for data to pass along to an upstream CIUMon. In collector mode, however, CIUMon does not initiate any communication with the upstream CIUMon; instead, it waits for that CIUMon to ask for requests.

By default, in relay mode the firewall would need to be configured to allow the relay CIUMon to communicate with UDP port 5099 of the upstream CIUMon. In collector mode, the firewall would need to be configured to allow the upstream CIUMon to communicate with UDP port 6099 of the relay CIUMon. Note that the direction of traffic, and which computer is the one listening, changes depending on the mode. Also, the default port is different in collector mode -- this is because the relay CIUMon also listens for Hyperview requests on port 5099 by default, so a different port needs to be chosen for communication with the upstream CIUMon. However, you can easily configure CIUMon to use other port numbers instead of these defaults.

4.7.2 Getting live data across an intermediate LAN with relay mode

Some networks have an intermediate LAN so that computers on the business LAN can access the historian computer, but not the DCS LAN. Relay mode or collector mode can be used in these setups to allow users on the business LAN to access live data in DBCO.

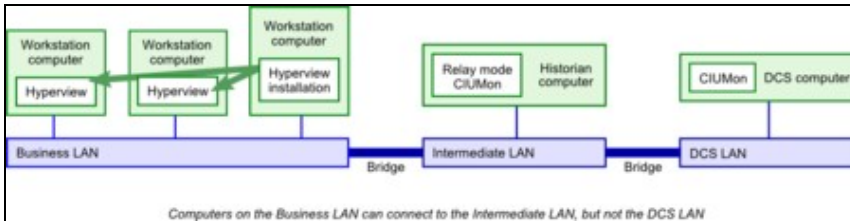

4.7.3 Getting live data directly from a business LAN

In some setups, it may be acceptable to run CIUMon on a server on your business LAN and connect it to a read-only RoviSys Turbo port on the DCS LAN through a serial line. RoviSys Turbo connects to the CIU and sends data back to the CIUMon on the business LAN. Because this setup uses a RoviSys Turbo read-only port, no changes to the DCS LAN or the plant can be made from the business LAN.

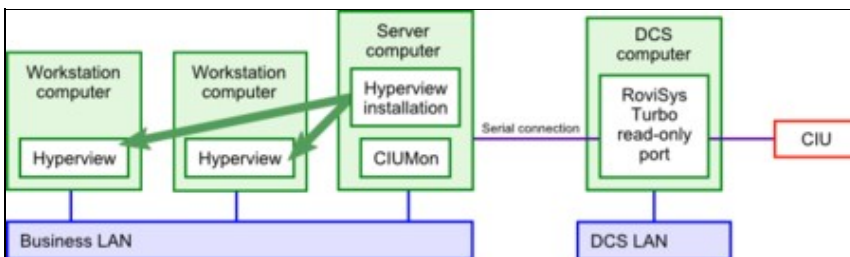

4.7.4 Running CIUMon in relay mode

In relay mode, CIUMon will send requests for data along to an upstream CIUMon, and pass back the responses. If there is a firewall between your users and the upstream CIUMon, you need only configure the firewall to allow the relay mode CIUMon to pass requests through it on a single UDP port, and this will allow all of your users to get data by communicating with the relay mode CIUMon. If your firewall rules require the upstream CIUMon to initiate all communications, you may use collector mode instead.

To run CIUMon in relay mode:

1. Load a new relay configuration: on the **File** menu, click **Load Configuration**. Then, select "New Relay Configuration" and click **OK**.
2. On the **Options** menu, click **Settings**.
3. Click **Relay mode**.
4. Type the IP address of the CIUMon that you want to connect to in the **Computer name or IP address of upstream CIUMon** box.

If you have changed the UDP port for the CIUMon you want to connect to, specify the port in the **UDP port of upstream CIUMon** box.

Once you have configured CIUMon to run in relay mode, save your configuration and make sure you can get data from your CIU.

 **Note:** In the display of the upstream CIUMon that is connected to the CIU, requests that come from the relay mode CIUMon will have the IP address of the relay mode CIUMon. However, the logon name will be the user who is using the data.

4.7.5 Running CIUMon in collector mode

In collector mode, CIUMon will wait for an upstream CIUMon to ask if there are any requests for data. Then, it will reply to the upstream CIUMon to send along any requests. If there is a firewall between your users and the upstream CIUMon, you need only configure the firewall to allow the upstream mode CIUMon to communicate through it on a single UDP port, and this will allow all of your users to get data by communicating with the collector receiver CIUMon. The collector receiver CIUMon does not initiate any communication with the upstream CIUMon; it waits for that CIUMon to ask for requests. If your firewall rules do not require the upstream CIUMon to initiate communications, you may use relay mode instead.

To set up the upstream CIUMon:

1. Start CIUMon on the upstream computer that is connected to your CIU.
2. If CIUMon is connected, disconnect it: on the **File** menu, click **Disconnect**.
3. On the **Options** menu, click **Settings**. Click the **Collector Source** tab. Select **Act as collector source**, and type the IP address of the computer where you want to set up CIUMon in collector mode. You may also select which UDP port will be used to communicate with the collector receiver CIUMon.
4. Click **OK**, and save your configuration. Then, connect CIUMon: on the **File** menu, click **Connect**.

To set up the collector mode CIUMon:

1. On the computer where you want to run CIUMon in collector receiver mode, Start CIUMon and load a new relay configuration: on the **File** menu, click **Load Configuration**. Then, select **(New Relay Configuration)** and click **OK**.
2. On the **Options** menu, click **Settings**.
3. Click **Collector Receiver**. Make sure that the port in the **Collector receiver UDP port** box matches the one on the **Collector Source** tab of the upstream CIUMon.
4. Click **OK** and save your configuration. Then, make sure you can get data from your CIU. Note that it may take about a minute before you can start getting data, as the collector CIUMon waits for the upstream CIUMon to establish a connection with it.

4.7.6 Is it safe to let everyone on the network access live data?

DBDOC's live data features are read-only. Remote users cannot change anything using DBDOC.

CIUMon does have the ability to restart your CIU, which may be useful in troubleshooting. This ability cannot be accessed remotely. It can only be used from the CIUMon computer that has a physical connection to the CIU.

4.8 Running CIUMon automatically (as a service)

Running CIUMon as a service ensures that CIUMon will run if the computer is restarted for any reason. It also restarts CIUMon after some errors in some circumstances, and allows CIUMon to run without any user logged in.

4.8.1 Setting up a CIUMon service

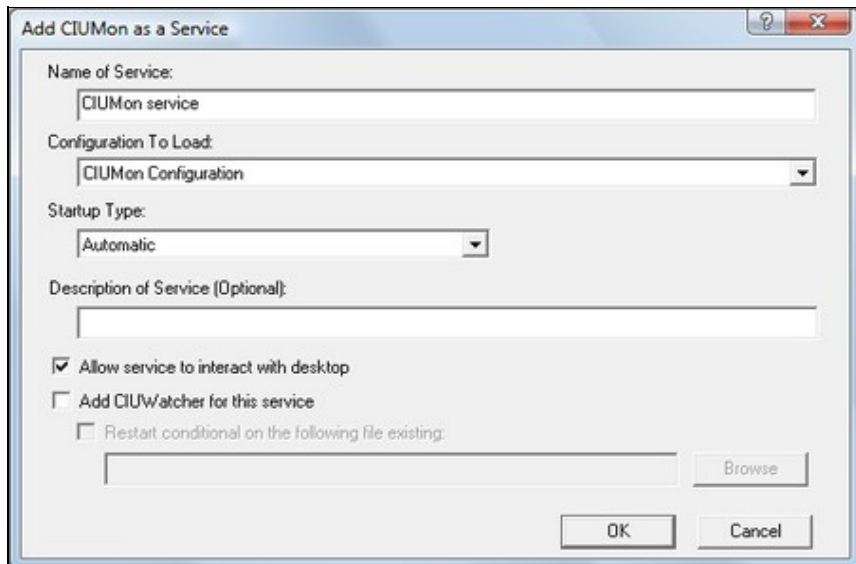

1. If CIUMon connects to your CIU through RoviSys Turbo, set up RoviSys Turbo to run automatically
2. On the **Options** menu, click **Services**.
3. Click **Add A Service**.
4. In the **Configuration To Load** list, click the configuration that the service will use.
5. If you like, you can make changes to the name for the service in the **Name of Service** box, or create a description in the **Description of Service** box.
6. Make sure that the **Allow service to interact with desktop** check box is cleared. Clearing this box causes CIUMon to run silently.
7. Click **OK**.
8. Click **Close**.
9. Close CIUMon and reboot the computer.

Note: You can also create a service using CIUMonController: in the CIUMonController window, click **Add a Service**.

4.8.2 Changing a CIUMon service

There are two types of settings that affect a CIUMon service: the settings in the configuration it is using, and the settings for the service itself. The different types of settings are changed in different ways.

The service settings can be changed through the Services window.

The logging and statistics options in the configuration can be changed using CIUMon Service Controller.

The other options in the configuration must be changed through CIUMon options.

To use CIUMon Service Controller,

- On the **Start** menu, under **Programs**, click **GMCL DBDOC** and then click **CIUMon Service Controller**.

- Or, in the folder where DBDOC was installed, open the **Programs** folder and run **CIUMonController.exe**.

To change service-only options:

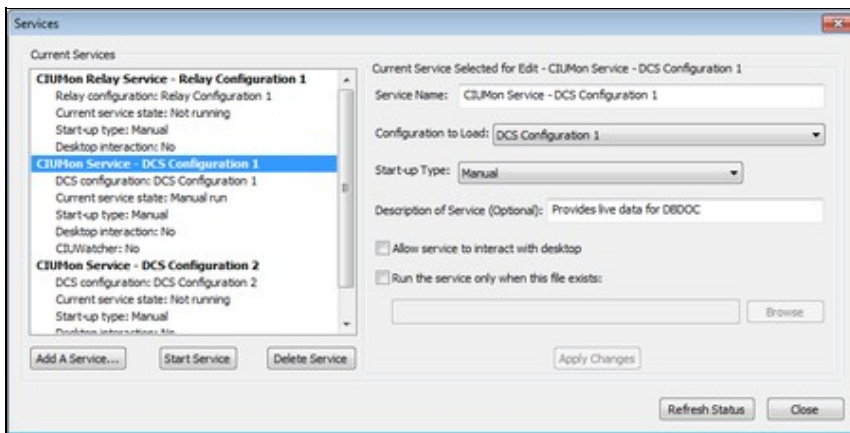

Use the **Services** window to start or stop a CIUMon service, prevent a service from starting when you reboot, make a service run in a window, or allow non-administrators to start and stop the service by renaming a file.

1. Open CIUMon.
2. On the **Options** menu, click **Services**.
3. In the **Current CIUMon Services** list, click the CIUMon service to be modified.
4. Change the service's options.
5. Click **Apply Changes**.

Note: You can also modify a service using CIUMonController: in the CIUMonController window, click the service you want to change and then click **Modify Service**.

To log CIUMon messages for troubleshooting:

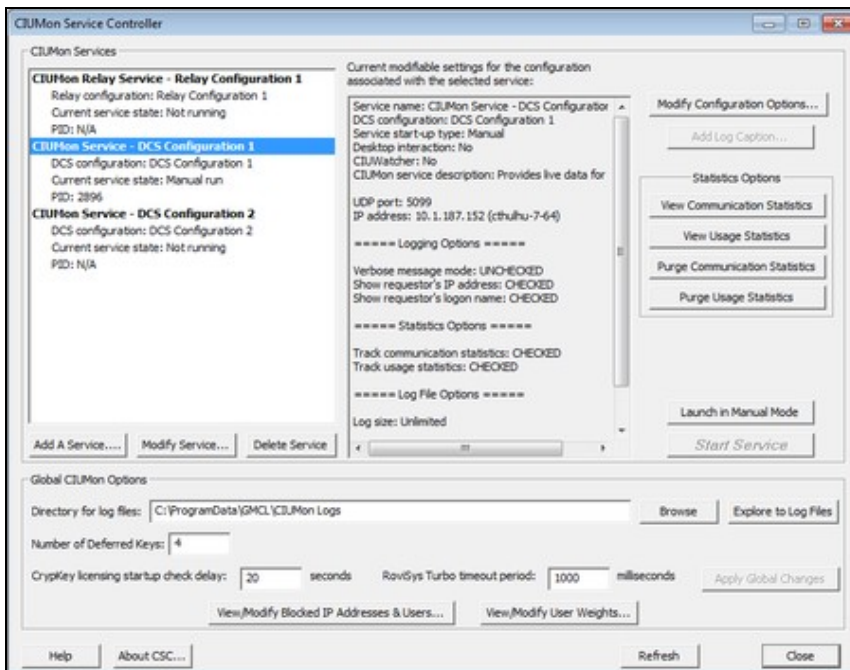

1. Start CIUMon Service Controller.
2. In the list of services, click the service that you want to create logs for.
3. Click **Modify Configuration Options**. Choose the options you want. Then, click **OK**.

 **Note:** Some options may not be available in CIUMon Service Controller. To access these options, stop the service and run CIUMon manually. Then, load the appropriate configuration. On the **Options** menu, click **Settings** and then select the **Logging Options** tab.

To view statistics about who is using live data:

1. Start CIUMon Service Controller.
2. In the list of services, click the service that you want to view statistics for.
3. In the **Statistics Options** box, click **View Communication Statistics** or **View Usage Statistics**.

To change other options:

1. Start CIUMon Service Controller.
2. Select the service you are modifying and click **Launch in Manual Mode**. If the service was running, it will stop. Then, a CIUMon window will open.
3. In CIUMon, change the options as required.
4. In CIUMon, save the configuration.
5. Quit CIUMon.
6. In CIUMon Service Controller, click **Start Service** to get your service running again.

 **Note:** If you are using an account without administrator privileges, you may still launch CIUMon Service Controller and make changes to services. However, when CIUMon Service Controller starts, you will be asked for the user name and password of an administrator account.

 **Note:** Logging options can be changed directly in CIUMon Service Controller. Service options can be changed without stopping the service.

4.8.3 Error recovery when running as a service

If CIUMon is running as a service and it stops without exiting cleanly (ie it crashes), it will be restarted. This should prevent live data from being unavailable, and avoids requiring the administrator.

If CIUMon crashes again within 30 seconds, it will not be restarted a second time, as this generally indicates a problem that requires attention. If this happens, please contact GMCL for further assistance.

4.8.4 How to tell if CIUMon is running as a service

If you are running CIUMon as a service, the CIUMon window will not normally be displayed on your computer. However, there are still several techniques that you can use to make sure that CIUMon is running properly.

- The best way to make sure that a CIUMon service is running properly is by checking if you can access live data in Hyperview. See Live Data Configuration in Hyperview and Displaying Slow Mode live data in Hyperview.
- You can also use CIUMon Service Controller to check if your CIUMon service is running. Start CIUMon Service Controller and check the **Current service state** in the list of services.
- If you have a single CIUMon service, you can use Windows Task Manager to check if it is running. Press CTRL+SHIFT+ESC to open Windows Task Manager. Click the **Processes** tab and look for

CIUMON.exe in the list of processes. If **CIUMON.exe** is not present, then the service is not running.

- You can temporarily configure a CIUMon service to interact with the desktop so that a window will appear when the service is running. However, in this windowed mode, CIUMon will not start until you log on, and it will stop when you log off. After you are finished troubleshooting, you should turn off this mode so that CIUMon will run even when you are not logged on.

4.8.5 Running RoviSys Turbo automatically

If DBDOC connects to your CIU using RoviSys Turbo, then in order to run CIUMon automatically, you will need to run RoviSys Turbo automatically.

Recent versions of RoviSys Turbo can be run as a service. Running RoviSys Turbo as a service ensures that it is always available, both for CIUMon and for other programs that use it, such as a Composer or WinCAD EWS computer.

Older versions of RoviSys Turbo can be started automatically by CIUMon instead.

To run RoviSys Turbo as a service:

1. Make sure CIUMon will not try to run RoviSys Turbo. In CIUMon, on the **Options** menu, click **CIUMon Settings**.
2. Click the **Communication Modes** tab.
3. Clear the **Launch RoviSys Turbo on start-up** check box.
4. In RoviSys Turbo, on the **View** menu, click **Run as Service**.

To run RoviSys Turbo from CIUMon:

1. On the **Options** menu, click **CIUMon Settings**.
2. Click the **Communication Modes** tab.
3. Select **Launch RoviSys Turbo on start-up**.

Note:

- RoviSys Turbo will usually perform best if it is running at high priority. To make sure that RoviSys Turbo runs at high priority, click **Priority** on RoviSys Turbo's **Edit** menu, and then click **High**.
- Some older versions of RoviSys Turbo do not have a feature to set the priority. For these older versions, use the **Set priority level of RoviSys Turbo** box in CIUMon to set RoviSys Turbo's priority. This feature will only work for these older versions of RoviSys Turbo.

4.8.6 Starting and stopping a CIUMon service with CIUWatcher

CIUWatcher can allow non-administrator users to stop and start CIUMon.

To allow non-administrator users to stop and start CIUMon, CIUWatcher looks for the existence of some file. When this file is deleted or moved, CIUMon is stopped. When this file is created or replaced in its original location, CIUMon is started again. By setting CIUWatcher to look for a file that any user can create or delete, you can allow any user to stop and start CIUMon.

To allow non-administrator users to stop and start CIUMon:

1. Decide where you will put the file that CIUWatcher will look for. Make sure that it can be moved or deleted and created by the users you would like to be able to stop and start CIUMon, and not by

- other users. Create the file.
2. Start CIUMon.
3. On the **Options** menu, click **Services**.
4. In the **Current CIUMon Services** list, click the service you would like other users to be able to stop and start.
5. Select **Run the service only when this file exists**.
6. Enter the location of the file for CIUWatcher to look for in the box below.
7. Click **Apply Changes**. Click **Close**.

4.8.7 Removing a CIUMon service

1. On the **Options** menu, click **Services**.
2. In the **Current CIUMon Services** list, select the service to remove.
3. Click **Delete Service**

Note: You can also remove a service using CIUMonController: in the CIUMonController window, click the service you want to remove and then click **Delete Service**.

4.9 Improving CIUMon's performance

There are various methods to improve the performance of CIUMon to make sure you are getting as much live data as possible and not slowing down the computer running CIUMon too much.

4.9.1 Limitations on how much live data you can get

Each CIU that CIUMon is connected to can provide around thirty values per second. Using RoviSys Turbo can greatly increase this amount. In many cases, a single CIU can provide enough live data for your users. This is because Hyperview is set up to use live data as efficiently as possible, and because there normally are not many users accessing live data all at once. If you need to control access to live data so that the users who need it most can get it, please look at Managing access to live data. If you need to get more live data, please look at Getting more live data.

Check your communication statistics to see how much live data has been requested from your system. Comparing the amount of data requested to the amount of data sent can indicate whether CIUMon is providing data quickly enough to meet the needs of your users.

4.9.2 Getting more live data

If you are not getting enough live data, there are several actions you can take. To make sure that you are getting as much data as possible from your current hardware, you should make sure CIUMon is running at high priority. You may also wish to adjust CIUMon's timing. As well, make sure that CIUMon is connected at a baud rate of at least 600.

In addition using RoviSys Turbo can greatly increase the amount of live data you can get.

Making sure CIUMon is running at high priority: CIUMon runs at high priority by default. The only reason it would run at lower priority is if someone changed the priority deliberately, perhaps to reduce CIUMon's impact on computer performance. Since lowering the priority can slow down live data, you may wish to raise the priority again.

To check whether CIUMon is running at high priority:

1. Press CTRL+SHIFT+ESC. Windows Task Manager will open.
2. Click the **Processes** tab.
3. Locate **CIUMON.exe** in the list of processes. Look at the **Base Priority** column for **CIUMON.exe**. It should be "High".

 **Note:** If there is no **Base Priority** column, then on the **View** menu, click **Select Columns**. Select the **Base Priority** check box and click **OK**.

Adjusting CIUMon's timing: When CIUMon requests data, it first sends a request for the CIU to fetch the desired value. Usually the data is not ready immediately, so CIUMon has to send a second request for the CIU to respond with the fetched value. The delay between these two requests is fixed at 50ms and is not adjustable.

If the data was not returned, then CIUMon retries up to the number of times specified by *Number of Retries*. The interval between consecutive requests is set by the *Response Retry Delay*.

The default *Response Retry Delay* is 60 milliseconds. In systems where the CIU is used with RoviSys Turbo, this may be too short. Lengthening the delay can reduce the number of times CIUMon requests each value, which can improve performance. In other systems, the CIU may have the data ready in less than 110 ms. In this case, shortening the delay can improve throughput slightly.

To change the response retry delay:

1. On the **Options** menu, click **Settings....**
2. In the **Response Retry Delay** box, type the new response retry delay (in milliseconds).

4.9.3 Reducing the impact of CIUMon on computer performance

CIUMon should have less impact on your computer's performance when it is run automatically. When it is run manually, it will have less impact on performance when it is minimized.

You can also reduce the amount of resources CIUMon uses by lowering it's priority. Lowering the priority will improve computer performance at the expense of CIUMon performance.

Changing CIUMon's priority: When CIUMon is run interactively, that is, when it either has been run manually or has been made to interact with the desktop, you can change the priority with which it runs.

The priority you set will affect all CIUMons that start (or restart) after you change the priority. However, it will not affect CIUMons that are already running, except the one in which you change the priority.

To change CIUMon's priority:

1. On the **Options** menu, click **Set Priority....** The **Set CIUMon Priority** window will appear.
2. In the list of priorities, click the priority at which CIUMon should run.
 - ◆ CIUMon performs best when it is running at **High** priority.
3. Click **OK**.

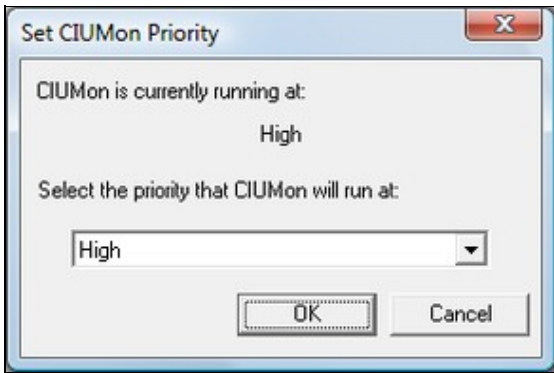

4.10 Managing access to live data

You may want to manage access to live data because the amount of live data available is limited, or for security or regulatory reasons.

With DBDOC, you can:

- Restrict access to live data;
- Track who is using live data;
- Allow some users to get more live data than others.

4.10.1 Restricting access to live data

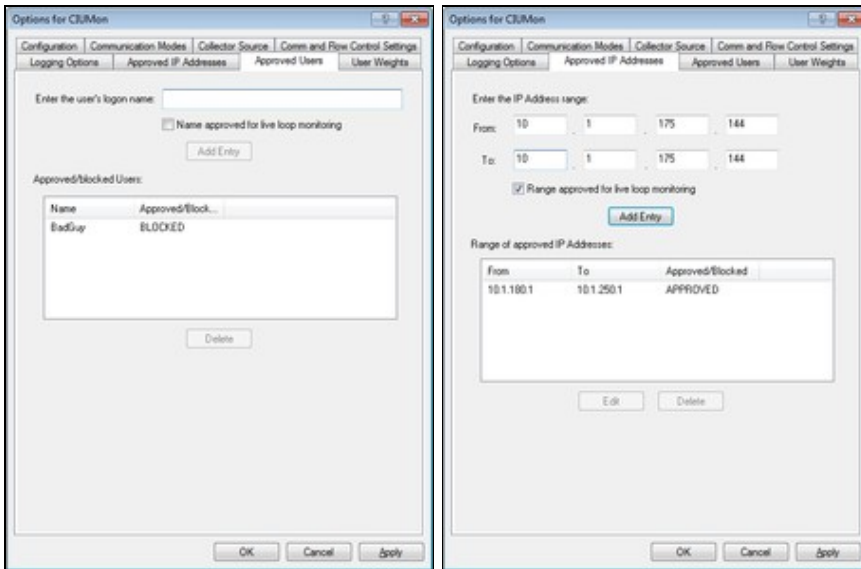

Because the amount of live data available is limited, it may be useful to restrict access to it. DBDOC provides two ways to do this: by Windows logon name or by IP address. Do not use both methods at the same time.

Live data access restrictions are not configuration specific. They are shared by every CIUMon and every configuration running on a given machine.

Blocked users who try to access live data will receive an error message letting them know that they have been blocked.

Restricting access to live data by Windows logon names: A logon name can be either blocked or approved. If any logon names are approved, only approved logon names will be able to access live data. There is no reason to both approve and block logon names.

Note: If a username has ever been changed, you must block or approve the original username. For example, if user "Smith" was originally user "John Smith," but the username was changed, you must block "John Smith." Blocking "Smith" will not work. This is due to how Windows stores usernames.

To approve or block access to live data by a Windows logon name:

1. On the **Options** menu, click **Settings...**
2. Click the **Approved Users** tab.
3. Do one of the following:
 - ◆ To allow the newly added user to get live data, select the **Name approved for live loop monitoring** checkbox.
 - ◆ To prevent the newly added user from getting live data, clear the **Name approved for live loop monitoring** checkbox.
4. Type the logon name to be added into the **Enter the user's logon name** box and click **Add Entry**.

Note: If any logon names are approved, only approved logon names will be able to access live data. There is no reason to both approve and block logon names.

To remove a Windows logon name from the list of approved or blocked logon names:

1. On the **Options** menu, click **Settings...**
2. Click the **Approved Users** tab
3. In the **Approved/blocked Users** list, click the logon name.
4. Click **Delete**.

Restricting access to live data by IP address: IP addresses (or ranges of IP addresses) can be either blocked or approved. If any IP addresses are approved, only IP addresses that are both approved **and** not blocked will be able to access live data. Using this feature, it is possible to approve a range of IP addresses but block some addresses in that range.

Note: There is an exception to the rule that only IP addresses that are both approved and not blocked can access live data. If you block a range of IP addresses and then approve a **single** IP address in that range, you will be able to get live data from that single address. This makes it possible to block a range of IP addresses but allow access from specific computers in that range.

To approve or block live data access from a single IP address:

1. On the **Options** menu, click **Settings...**
2. Click the **Approved IP addresses** tab
3. In the **From** boxes, type the IP address. It will appear in the **To** boxes as you type.

4. Do one of the following:
 - ◆ To allow the IP address to access live data, select the **Range approved for live loop monitoring** checkbox.
 - ◆ To block the IP address from accessing live data, clear the **Range approved for live loop monitoring** checkbox.
5. Click **Add Entry**.

To approve or block live data access from a range of IP addresses:

1. On the **Options** menu, click **CIUMon Settings**.
2. Click the **Approved IP addresses** tab
3. In the **From** boxes, type the first IP address in the range.
4. In the **To** boxes, type the last IP address in the range.
5. Do one of the following:
 - ◆ To allow IP addresses in the range to access live data, select the **Range approved for live loop monitoring** checkbox.
 - ◆ To block IP addresses in the range from accessing live data, clear the **Range approved for live loop monitoring** checkbox.
6. Click **Add Entry**.

To change an IP address or range of IP addresses in the list of approved or blocked IP ranges:

1. On the **Options** menu, click **CIUMon Settings**.
2. Click the **Approved IP addresses** tab
3. In the **Range of approved IP addresses** box, click the IP address or range that you would like to change.
4. Click **Edit**.
5. Make any changes you want to this IP address or range. For example, you can change whether the IP address is approved or blocked. Then, click **OK**.

To remove an IP address or range of IP addresses from the list of approved or blocked IP ranges:

1. On the **Options** menu, click **CIUMon Settings**.
2. Click the **Approved IP addresses** tab
3. In the **Range of approved IP addresses** box, click the IP address or range.
4. Click **Delete**.

4.10.2 Tracking who is using live data

Communication Statistics Detailed

As of: Jan 19 2012 11:13:11

IP Address	User Logon	Request Type	First Request Time	La
10.1.187.79	GMCL	read output 1 50 02 522	Jan 19 2012 11:13:05	Ja
10.1.187.79	GMCL	read output 1 50 02 527	Jan 19 2012 11:13:05	Ja
10.1.187.79	GMCL	read output 1 50 02 1150	Jan 19 2012 11:13:05	Ja
10.1.187.79	GMCL	read output 1 50 02 1151	Jan 19 2012 11:13:00	Ja
10.1.187.79	GMCL	read output 1 50 02 1263	Jan 19 2012 11:13:00	Ja
10.1.187.79	GMCL	read output 1 50 02 1268	Jan 19 2012 11:13:00	Ja
10.1.187.79	GMCL	read output 1 50 02 1295	Jan 19 2012 11:13:00	Ja
10.1.187.79	GMCL	read output 1 50 02 1434	Jan 19 2012 11:13:00	Ja
10.1.187.79	GMCL	read output 1 50 02 1535	Jan 19 2012 11:13:00	Ja
10.1.187.79	GMCL	read output 1 50 02 1536	Jan 19 2012 11:13:00	Ja
10.1.187.79	GMCL	read output 1 50 02 1537	Jan 19 2012 11:13:00	Ja

Show Summary Save To File... Update OK

CIUMon has two options for tracking usage. Communication statistics and usage statistics track slightly different information. They each provide a summary report and a detailed report, which display different information. These reports can be accessed through the Options menu. Statistics from both types of usage tracking can be saved to a file.

4.10.3 Allowing some users to get more live data than others

Options for CIUMon

Configuration | Communication Modes | Collector Source | Comm and Flow Control Settings

Logging Options | Approved IP Addresses | Approved Users | User Weights

Enter the user's logon name: CIUMonUser

User Weight: 10

Add Entry

User Weights:

Name	Weight
GoodUser	3

Delete

OK Cancel Apply

One way to deal with the limitations on how much live data you can get is to give some users more live data than others, by assigning them a higher user weight. For instance, a user with a user weight of two will get twice as much data as a user with a user weight of one. By default, all users have a user weight of one.

To assign a user weight:

1. On the **Options** menu, click **CIUMon Settings**.
2. Click the **User Weights** tab.
3. Type the user's logon name in the **Enter the user's logon name** box.
4. In the **User Weight** list, click the user weight to be assigned.
5. Click **Add Entry**.

To delete an assigned user weight:

1. On the **Options** menu, click **CIUMon Settings**.
2. Click the **User Weights** tab.
3. In the **User Weights** list, click the user weight to be deleted.
4. Click **Delete**.